

# Datasheet

## 规格书

3mm Super Bright White LED  
3 毫米直径超亮白色发光二极管

3A4 Series/系列 Angle/角度:25°

Class/级别:Q

Part No/型号:YL-3MM-4SWQ4N2



<b>Approval</b> 批准	<b>Checked</b> 审核	<b>Prepared</b> 制定
牛焕东	王华鹏	杨成琼

S.D.N. / D.N. No./ 送货单编号:	
Customer Name/客户名称:	
Sample Approval Signature/客户确认签署:	
Date/日期:	

## Features

特性  
**Standard T-1 Diameter Type Package.**  
 标准 T-1 直径封装  
**General Purpose Leads**  
 适合一般用途  
**Reliable and Rugged**  
 坚固可靠

## Absolute Maximum Ratings /最大限定参数 (Ta=25°C)

Parameter 参数	MAX. 最大值	Unit 单位
Power Dissipation 容损功率	100	mW
Peak Forward Current 峰值正向电流 ( $\leq 1/10$ Duty Cycle, 0.1ms Pulse Wide)	100	mA
Continuous Forward Current 一般正向电流	20	mA
Reverse Voltage 反向电压	5	V
Operating Temperature Range 正常工作温度范围	-40°C ~ +80°C	
Storage Temperature Range 储存温度范围	-40°C ~ +80°C	
Lead Soldering Temperature 焊接温度 [3mm (From solder joint to epoxy body)] [3mm (由焊接点至胶体的距离)]	260°C (for 3 seconds) 260°C (最多持续 3 秒)	

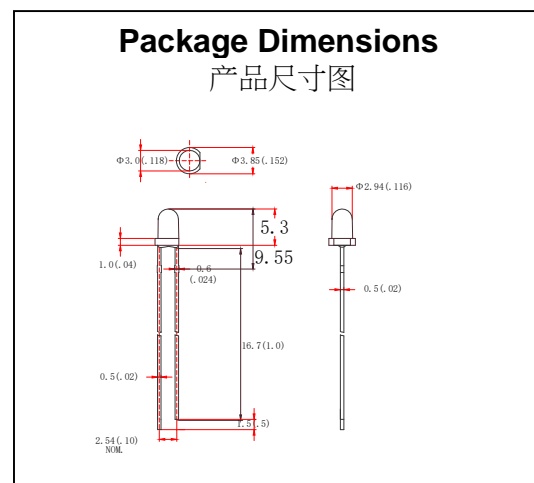

## Electro-Optical Characteristics 光电参数 (Ta=25°C)

Part Number 型号	Lens Color 胶体颜色	Source Color 发光颜色	Luminous Intensity 亮度 (lv / mcd) IF = 20mA (Note 5)			Forward Voltage 正向电压 (VF / V) IF = 20mA			Viewing Angle 角度 (Note 6)
			Min. 最小值	Typ. 平均值	Max. 最大值	Min. 最小值	Typ. 平均值	Max. 最大值	
YL-3MM-4SWQ4-N2	Water Clear	White	4900	6300	---	2.8	---	3.4	25°
Reverse Voltage $V_R = 5V$					Reverse Current $I_R \leq 5\mu A$				

## Notes/备注:

1. All dimensions are in millimeter.  
所有尺寸单位为毫米
2. Tolerance of measurement is  $\pm 0.25\text{mm}(.01")$  unless others otherwise noted.  
如沒有特別標示，正常的尺寸误差为 $\pm 0.25\text{mm}(.01")$
3. Protruded resin under flanges is 0.5mm max.  
凸出来树脂的外缘厚度最大是 0.5mm
4. Lead spacing is measured where the leads emerge from the package. LED  
脚长是由 LED 的胶体底部开始量起
5. Luminous intensity is measured with a light sensor and filter combination that approximates the CIE eye-response curve.  
光度标准是根据 CIE 人眼敏感度曲线图测试  
Tolerance of measurement of luminous intensity is  $\pm 15\%$ .  
发光强度的测量误差是  $\pm 15\%$
6.  $_{1/2}$  is the off-axis angle at which the luminous intensity is half the axial luminous intensity.  
Tolerance of measurement of angle is  $\pm 5$  degree.  
 $_{1/2}$  半视角，测试标准为于中间轴亮度的一半，误差 $\pm 5$
7. Caution in ESD: Static Electricity and surge damages the LED. It is recommended to use a wrist band or anti-electrostatic glove when handling the LED. All devices, equipment and machinery must be properly grounded.  
小心静电，静电会对 LED 造成伤害。建议使用 LED 时，应佩戴防静电手套及所有仪器均须接地。
8.  $\lambda_d \pm 1\text{nm}$ , X and Y are CIE1931; Color Coordinates Measurement allowance is  $\pm 0.01$   
波长的误差为  $\pm 1\text{nm}$ ; X/Y 是参照 CIE1931，色坐标 X/Y 的误差为  $\pm 0.01$ ;
9. Specifications are subject to change without notice.  
规格书会因应情况需要更改而不会另行通知

## Typical Characteristic for Super Bright White LED / 光电特性曲线

Forward Current vs. Chromaticity Coordinate ( $\lambda D$ )  
电流与色坐标曲线关系

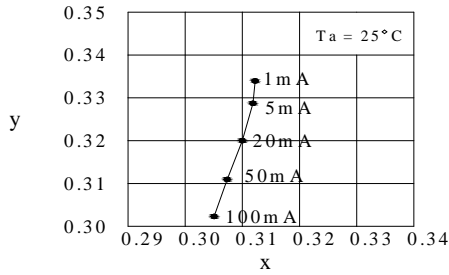

Spectral Distribution  
波长曲线图

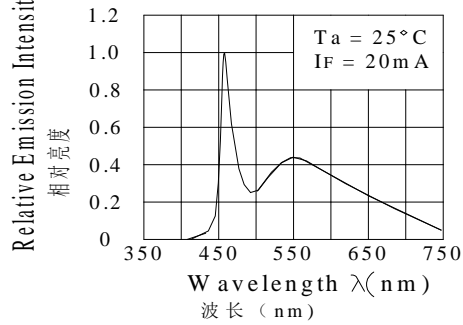

Ambient Temperature vs. Chromaticity Coordinate ( $\lambda D$ )  
环境温度与色坐标曲线关系

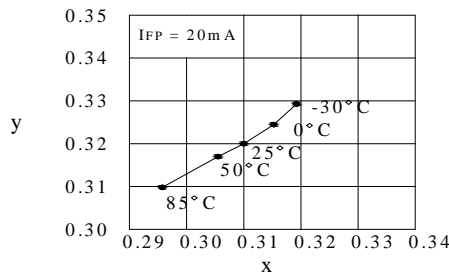

Directivity (Angle : 25°)  
角度与发光度曲线关系

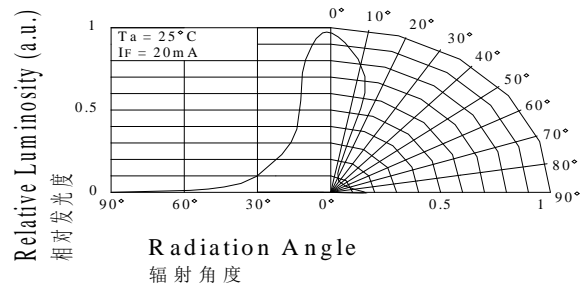

Forward Voltage vs. Forward Current  
电压与电流曲线关系

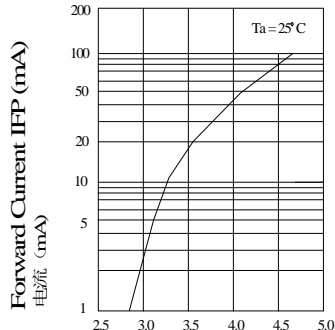

Forward Current vs. Relative Luminosity  
电流与光通量曲线关系

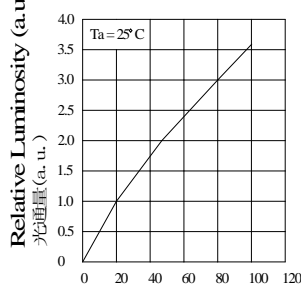

Duty Ratio vs. Allowable Forward Current  
负荷率与电流曲线关系

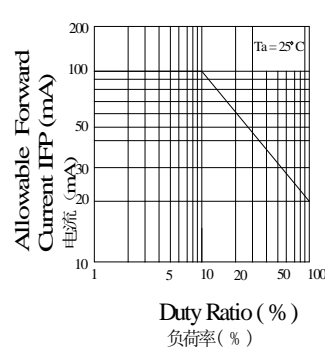

Forward Voltage (V)  
电压 (V)

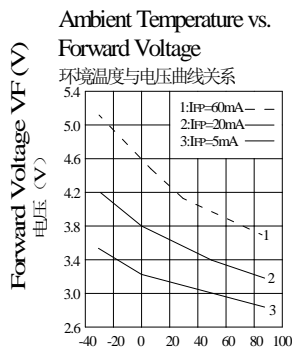

Ambient Temperature Ta (°C)  
环境温度 (°C)

Forward Current IFP (mA)  
电流 (mA)

Ambient Temperature vs. Relative Luminosity  
环境温度与相对亮度曲线关系

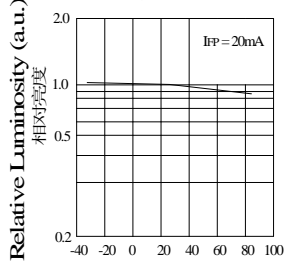

Ambient Temperature Ta (°C)  
环境温度 (°C)

Ambient Temperature vs. Allowable Forward Current  
环境温度与正向电流曲线关系

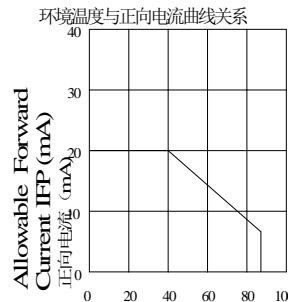

Ambient Temperature (°C)  
环境温度 (°C)

**Chromaticity Coordinates for Bin Grading:**

色区坐标

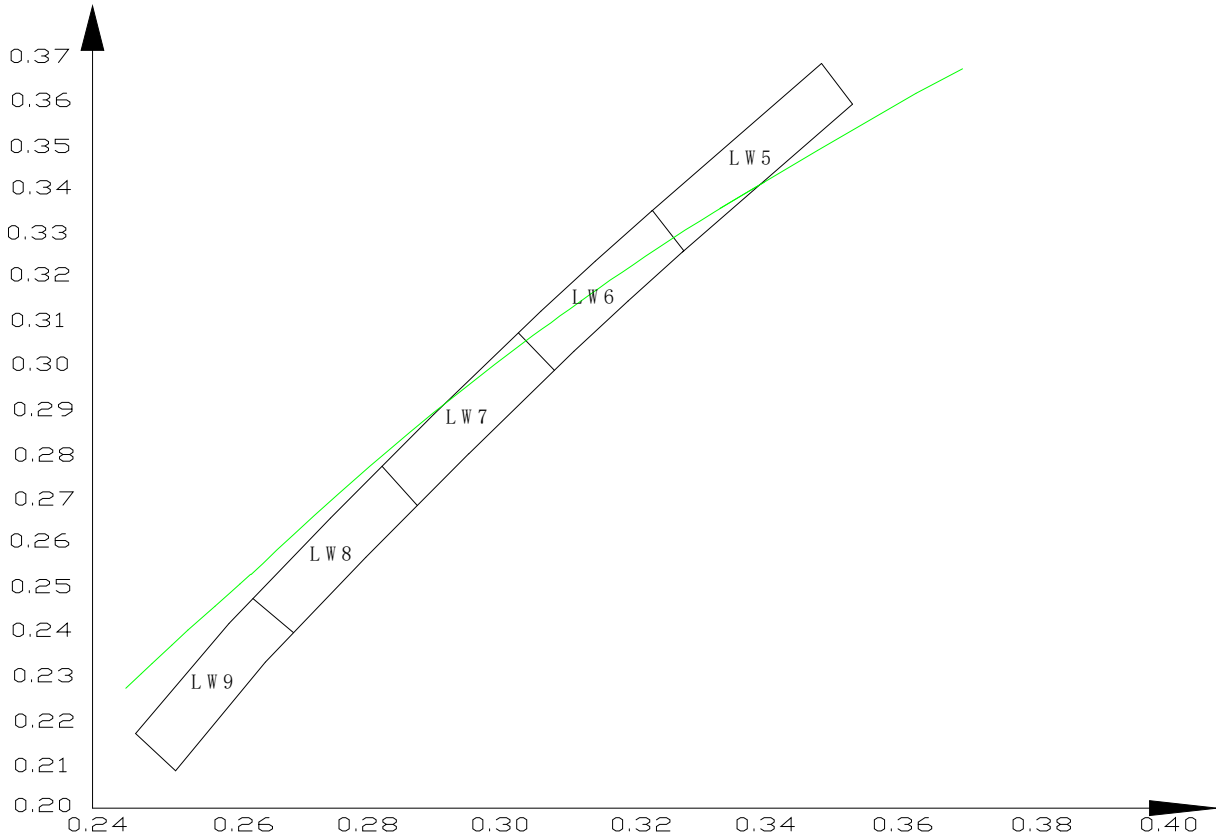

**Notes:**

Color Ranks		White			
LW5	X	0.3065	0.3124	0.3391	0.3332
	Y	0.3270	0.3186	0.3676	0.3760
LW6	X	0.2865	0.2924	0.3191	0.3132
	Y	0.2903	0.2819	0.3309	0.3393
LW7	X	0.2731	0.2790	0.3057	0.2998
	Y	0.2658	0.2574	0.3064	0.3148
LW8	X	0.2597	0.2656	0.2924	0.2865
	Y	0.2413	0.2329	0.2819	0.2903
LW9	X	0.2464	0.2523	0.2790	0.2731
	Y	0.2168	0.2084	0.2574	0.2658

Color	Group	Customer Ranks	Factory code	Reference TC(K)
White	5	LW5	LDc-f	5500-6500
	6	LW6	LD9-c	6500-8500
	7	LW7	LD7-a	8000-12000
	8	LW8	LD5-8	10000-20000
	9	LW9	LD3-6	15000-30000

Note: actual product chromaticity coordinates of points with color BIN shall prevail ; Tolerance of Color Temperature 2500K-5000K±5% , 5000-20000K±10% ;

备注：产品实际色度以色坐标分BIN为准；参考色温误差：2500K-5000K±5%，5000-20000K±10%；

## 发光二极管使用注意事项

### 一、 引脚构成

- a.从卡点到胶体底部至少要留有 3mm 的空间。
- b.不要使用胶体底部作为支撑点。
- c.由于压力会使胶体破裂，所以不要对胶体施加任何压力。
- d.将 LED 焊接在线路板上时，线路板上的过孔距离应和 LED 的引脚距离相适应。这样就不会因引脚的撑力而破坏胶体，导致 LED 的老化。

### 二、 存放

- a.LED 的存放温度应在 30° 以下，湿度在 70%以下。正常的存放期限是 3 个月。
- b.如果要求存放时间超过 3 个月，就应该在一个充有氮气和放有空气干燥剂的环境中存放，这样就能存放一年。
- c.避免不断改变储存的环境温度，特别是在有可能产生外露的高湿度环境。

### 三、 静电

- a.静电和浪涌电压会损坏 LED。
- b.在接触 LED 时，应戴防静电手套和防静电环。
- c.所有的机台和设备必须良好地接地。
- d.在使用 LED 的设备中应有抗浪涌电压的措施。
- e.损坏的 LED 会出现如下特征，如漏电流增大，正向电压降低，低电流不能点亮。在正常的标准 ( $V_F > 2.0V$  在  $I_F = 0.5mA$ )。

### 四、 散热

- a.成品的散热设计是非常重要的。在设计系统时，要考虑 LED 的散热情况。
- b.散热与电路板的散热能力和 LED 的摆放密度，以及其他组件的分布有很大的关系。建议使用时，避免升温过快，应在规格书指定的参数最大值下使用。
- c.应考虑环境温度后才去决定使用 LED 的电流。

### 五、 清洁

- a.建议使用乙醇来清洗 LED。当使用其他溶剂时，应保证该溶剂不会溶解树脂。
- b.不要以超声波清洗 LED。如果必要的话应考虑超声波的强度和其他因素，在清洗之前，要做试验证实不会损害 LED。

### 六、 对眼睛的安全指南

- a.1993 年，国际电子委员会发布了一套关于激光产品的安全标准(IEC 825-1)。此后，这个标准被应用于 LED。自 1998 IEC 60825-1 评估了光源的亮度等级。
- b.2001 年 IC 60825-1 第二版校正，修改了激光产品为第 7 类产品。
- c.包含可见光的 LED 产品被分在第一类产品。包含不可见光的紫外光的产品被分在第二类。发光角度小，发光强度大。在以上产品上，建议眼睛避免长期接受其光照。按照 ICE 的安全标准在产品上作出标记。

## 七、 LED 的焊接 条件

- a. 焊接时应注意焊接方式。
- b. 焊接位置不能低于环氧树脂基座 3mm 处。
- c. 推荐焊接条件

浸锡焊接		手动焊接	
预热温度	120°C Max.	焊接温度	350°C Max.
预热时间	60 sec. Max.	焊接时间	3 sec. Max.
浸锡温度	260°C Max.	焊接位置	不低于环氧树脂基座 3mm 处
浸锡时间	60 sec. Max.		
浸锡位置	不低于环氧树脂基座 3mm 处		

### d. 手动焊接

1. 当手动焊接时，建议使用夹具固定 LED 防止外力由 LED 的引脚传到胶体内部，否则会崩断胶体内部的金线。
2. 要保证 PCB 板过孔的孔径适合 LED 引脚的大小。否则在插入时，外力会通过引脚挤压胶体的内部，导致崩断金线。

### f. 自动焊接的 PCB 板尺寸

1. PCB 在焊接时会有轻微的弯曲，在尺寸大的 PCB 板中特别明显。焊接后，发现 LED 有高不良率，必须检查 PCB 板的大小，检查 PCB 板在焊接时是否已经弯曲了。如果发生这种现象，LED 的引脚会稍微弯曲，这样会崩断胶体内部的金线。
2. 最好以小型 PCB 板来焊接 LED。
3. 当使用大型的 PCB 焊接时，需要使用专用的夹具防止焊接时 PCB 板弯曲。

### g. 焊接注意事项：

1. 焊接及加热过程中不能对 LED 产生任何外力，LED 焊接后不能重新定位及移动。
2. 焊接后的 LED，环氧树脂应防止受到机械冲击或振动，直到 LED 恢复到室内温度。
3. 为防止 LED 焊接后死灯，应最大限度的减少对 LED 机械用力的作用。
4. 在 LED 剪脚时，需待 LED 灯珠冷却到室温后进行，在高温下进行剪脚可能会导致 LED 死灯。

## 八、 其他

- a. 必须确保正反向电压不能超出最大额定值，在使用 LED 时，必须保持正向电流为 20mA。
- b. 在这些注意事项中，LED 是被描述使用于普通的电子设备（例如办公设备、通讯器材、测量仪器和家用电器）。要在其它特殊的应用场合，请先咨询 YesLED 的销售人员。特别是当 LED 用在有故障时会危害生命或健康的场合（例如飞机、航天航空、潜艇、核反应堆、汽车、交通控制设备、生命维持系统和保险装置等等）。

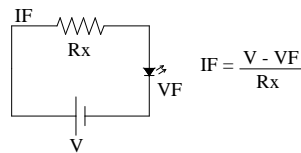

- c. 在没有得到 YesLED 的同意，用户不应以背着工程对 LED 进行拆卸或分析。如发现 LED 有问题，用户要直接拆卸或分析 LED 之前必须先通知 YesLED。
- d. 在大批量采购之前，必须有双方交换确认和盖章的合同。
- e. 产品的外观和规格会因情况需要更改而不另行通知。

## **CAUTIONS- Super Bright LED**

### **(1) Lead Forming**

- a. At least 3mm from the base of the epoxy bulb should be kept when forming leads.
- b. Do not use the base of the leadframe as a fulcrum during lead forming.  
Lead forming should be done before soldering.
- c. Because the stress to the base may damage the characteristics or it may break the LEDs, do not apply any bending stress to the base of the lead
- d. When mounting the LEDs onto a PCB, the holes on the circuit board should be exactly aligned with the leads of the LEDs. Stress at the leads should be avoided when the LEDs are mounted on the PCB, because it causes damage to the epoxy resin and this will degrade the LEDs.

### **(2) Storage**

- a. The LEDs should be stored at 30 C or less and 70%RH or less after being shipped and the storage life limits are 3 months.
- b. If the LEDs are stored more than 3 months, they can be stored for a year in a sealed container with a nitrogen atmosphere and moisture absorbent material.
- c. Please avoid rapid transitions in ambient temperature, especially, in high humidity environments where condensation can occur.

### **(3) Static Electricity**

- a. Static electricity or surge voltage damages the LEDs.
- b. It is recommended that a wristband or an anti-electrostatic glove be used when handling the LEDs.
- c. All devices, equipment and machinery must be properly grounded.
- d. It is recommended that measures be taken against surge voltage to the equipment that mounts the LEDs.
- e. Damaged LEDs will show some unusual characteristics such as the leak current remarkably increases, the forward voltage becomes lower, or the LEDs do not light at the low current.  
Criteria: ( $V_F > 2.0V$  at  $I_F = 0.5mA$ )

### **(4) Heat Generation**

- a. Thermal design of the end product was most important. Please consider the heat generation of the LED when making the system design.
- b. The thermal resistance of the circuit board and density of LED placement on the board, as well as other components was the important factor affecting the coefficient of temperature increase per input electric power. It must be avoided intense heat generation and operate within the maximum ratings given in the specification.
- c. The operating current should be decided after considering the ambient maximum temperature of LEDs.

### **(5) Cleaning**

- a. It is recommended that isopropyl alcohol be used as a solvent for cleaning the LEDs. When using other solvents, it should be confirmed beforehand whether the solvents will dissolve the resin or not. Freon solvents should not be used to clean the LEDs because of worldwide regulations.
- b. Do not clean the LEDs by the ultrasonic. When it is absolutely necessary, the influence of ultrasonic cleaning on the LEDs depends on factors such as ultrasonic power and the assembled condition. Before cleaning, a pre-test should be done to confirm whether any damage to the LEDs would occur.

### **(6) Safety Guideline for Human Eyes**

- a. In 1993, the International Electric Committee (IEC) issued a standard concerning laser product safety (IEC 825-1). Since then, this standard has been applied for diffused light sources (LEDs) as well as lasers. In 1998 IEC 60825-1 Edition 1.1 evaluated the magnitude of the light source.
- b. In 2001 IEC 60825-1 Amendment 2 converted the laser class into 7 classes for end products.
- c. Components are excluded from this system. Products which contain visible LEDs are now classified as class 1. Products containing UV LEDs can be classified as class 2 in cases where viewing angles are narrow, optical manipulation intensifies the light, and/or the energy emitted is high. For these systems it is recommended to avoid long term exposure. It is also recommended to follow the IEC regulations regarding safety and labeling of products.



## (7) Soldering Condition for LED Lamps

- a. Careful attention should be paid during soldering.
- b. Solder the LED no closer than 3mm from the base of the epoxy bulb. Soldering beyond the base of the tie bar is recommender.
- c. Recommender soldering conditions

Dip Soldering		Soldering	
Pre-Heat	120°C Max	Temperature	350°C Max
Pre-Heat	60 seconds Max	Soldering	3 seconds Max
Time	260°C Max	Time	No closer than 3
Solder Bath		Position	mm from the
	10 seconds Max		base of the
Temperature	No lower than 3 mm		epoxy bulb.
Dipping			
Time			
Dipping			
Position			

- d. For manual soldering, it is recommended a fixture be used to prevent damage to the inner structure of the LED.  
The lead pitch of the LED must match the pitch of the mounting holes on the PCB during component placement.  
Stress applied on the lead, particularly when heated, may cause damage to the conducting elements inside the LED.
- e. For auto-soldering, ensure the PCB is of proper orientation as otherwise the lead may be bent slightly after soldered, which also apply stress on the LED. Use specific fixture whenever necessary.
- f. NO stress should be applied on the LED during soldering or other heating processes, the LED should NOT be repositioned after soldering.  
Avoid any mechanical stress or shock to the epoxy lens until the LED is cooled down to the room temperature.  
Minimize the mechanical stress applied onto the LED.  
Cut the LED leadframes at room temperature. Cutting the leadframes at high temperatures may cause failure of the LEDs.

## (8) Others

- a. Care must be taken to ensure that the reverse voltage will not exceed the absolute maximum rating when using the LEDs with matrix drive. Keeping the Normal Forward to 20 mA.
- b. The LEDs described in this manual are intended to be used for ordinary electronic equipments (such as office equipment, communications equipment, measurement instruments and household appliances). Consult YesLED's sales staff in advance for information on the applications in which exceptional quality and reliability are required, particularly when the failure or malfunction of the LEDs may directly jeopardize life or health (such as for airplanes, aerospace, submersible repeaters, nuclear reactor control systems, automobiles, traffic control equipment, life support systems and safety devices).

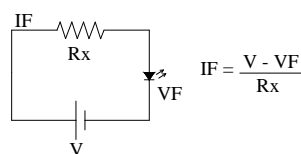

- c. User shall not reverse engineer by disassembling or analysis of the LEDs without having prior written consent from YesLED. When defective LEDs are found, the User shall inform YesLED directly before disassembling or analysis.
- d. The formal specifications must be exchanged and signed by both parties before large volume purchase begins.
- e. The appearance and specifications of the product may be modified for improvement without notice.