

FEATURES AND APPLICATIONS

- Low UVA wavelength, highly consistent
- HVPE epitaxy process, patent protected, unique in the industry
- UV lamps for industrial curing applications and medical/biomedical uses

SPECIFICATIONS

Absolute Maximum Rating (Ta = 25°C)

Item	Symbol	Maximum Rating	Unit
DC Forward Current	I _f	30	mA
Pulse Forward Current*	I _{fp}	80	mA
Reverse Current	I _{Rz}	200	mA
Operating Temperature	T _{opr}	-20 to +80	°C
Storage Temperature	T _{stg}	-40 to +100	°C

*Condition: Duty Cycle: 1/10, Pulse Width: 10msec

Optical and Electrical Characteristics (Ta = 25°C)

Item	Symbol	Condition	Min	Typ.	Max	unit
Forward Voltage	V _f	I _f =20mA	3.6	4.3	5.0	V
Reverse Voltage	V _{Rz}	I _R =5mA	0.7	0.9	1.5	V
Peak Wavelength	λ _p	I _f =20mA	360	361	363	nm
Viewing Angle		I _f =20mA	-	10	-	deg.
Output Power/Flux	P _o	I _f =20mA	200	400	700	μW

LED Dimensions (typical)

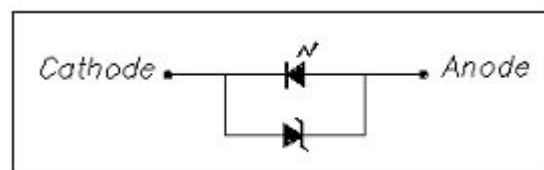
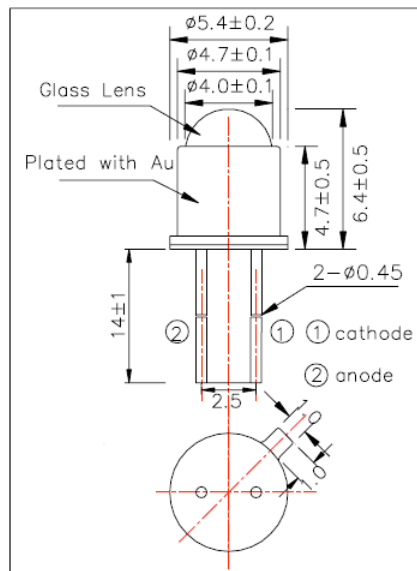

- TO-18 stem type mount
- Glass ball lens
- 5° viewing half angle
- Covered and hermetically sealed
- Zener diode protection

Typical Spectrum

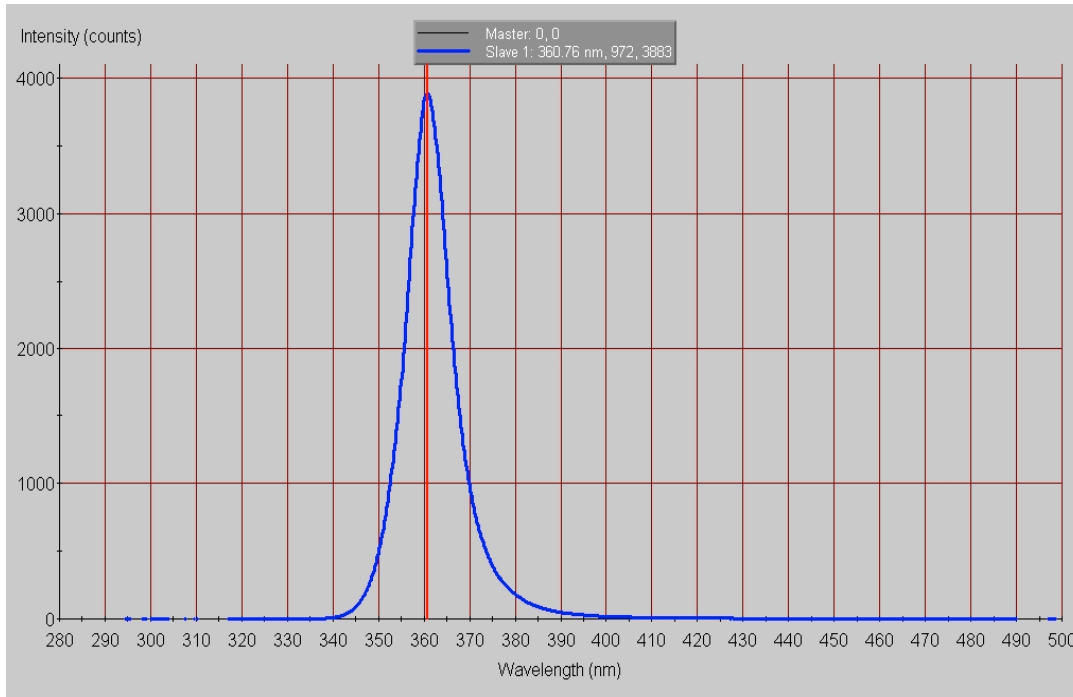

Warnings and Handling Instructions

- **UV LEDs emit intense but mainly invisible ultraviolet radiation when in operation, which may be harmful to eyes, even for brief periods.**
- *** DO NOT LOOK DIRECTLY INTO THE UV LED DURING OPERATION ***
- *** BE SURE THAT YOU AND ALL PERSONS IN THE VICINITY WEAR SAFETY GOGGLES THAT PROVIDE SUITABLE UV PROTECTION WHEN A UV LED IS OPERATING ***
- *** KEEP CHILDREN AWAY FROM THE OPERATING VICINITY ***
- *** KEEP UV LEDs OUT OF THE REACH OF CHILDREN ***
- **If you incorporate a UV LED into a product, be sure to provide appropriate cautionary labels and instructions.**
- **Please follow all standard procedures for storing, handling, cleaning, mounting, soldering, disposal, or otherwise handling LED dies or packaged LEDs, including static electricity protection.**

Typical Electrical and Optical Characteristics Curves

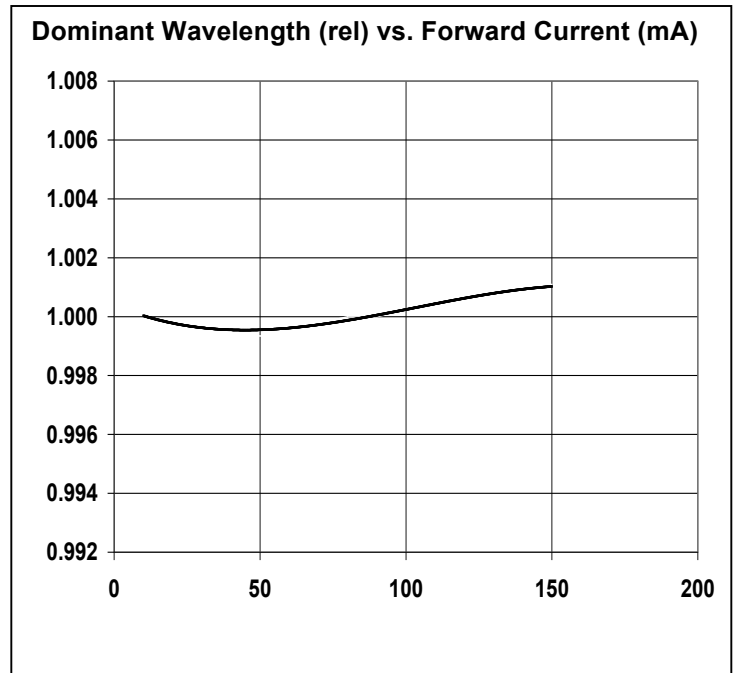
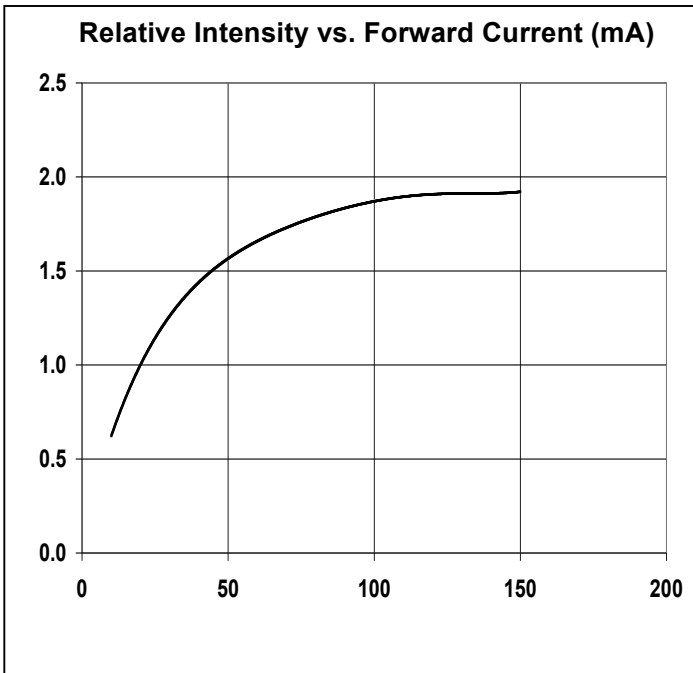
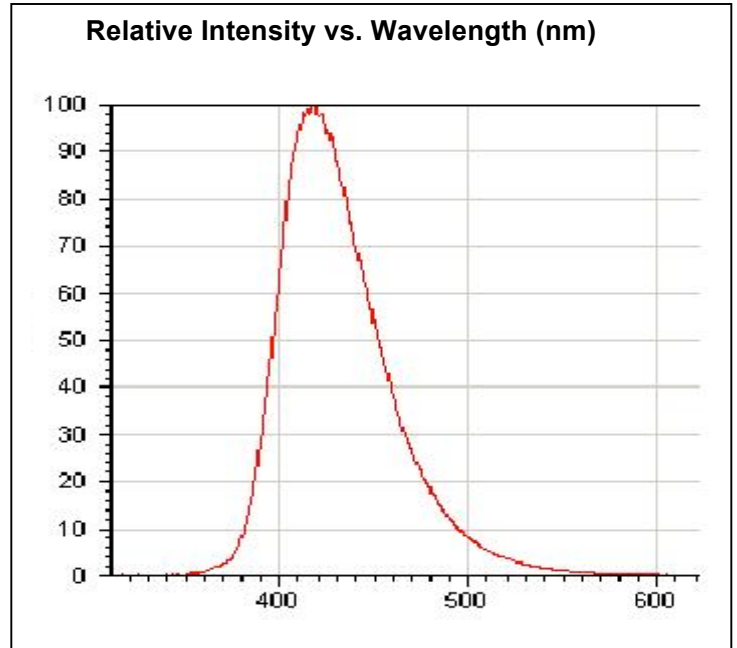
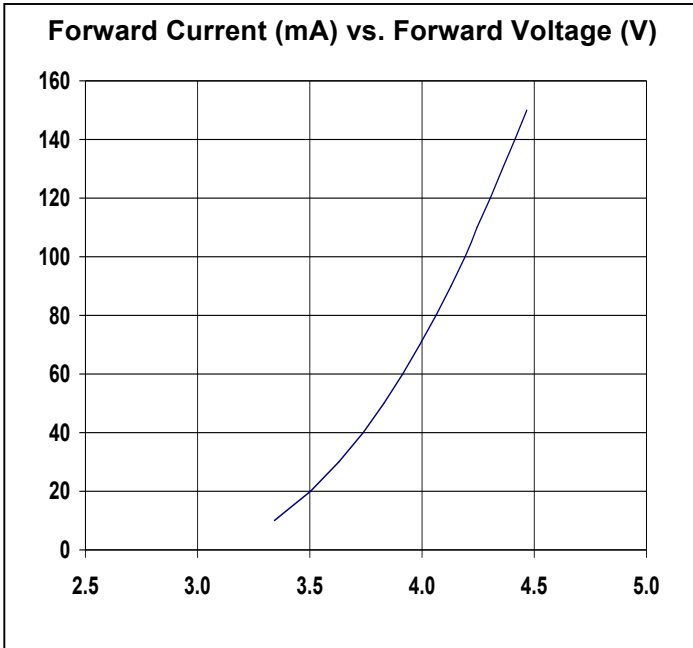

These are typical measurements, representative of specific production lots; actual curves may vary.

Typical Electrical and Optical Characteristics Curves

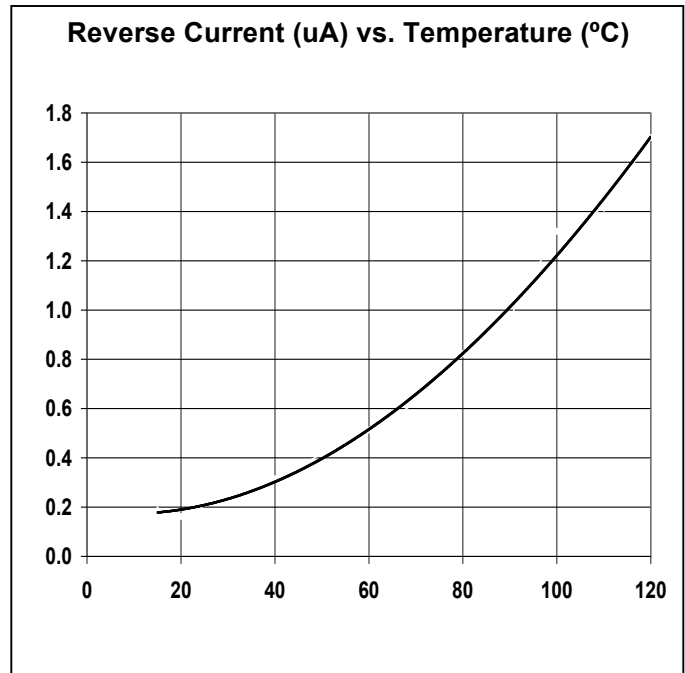
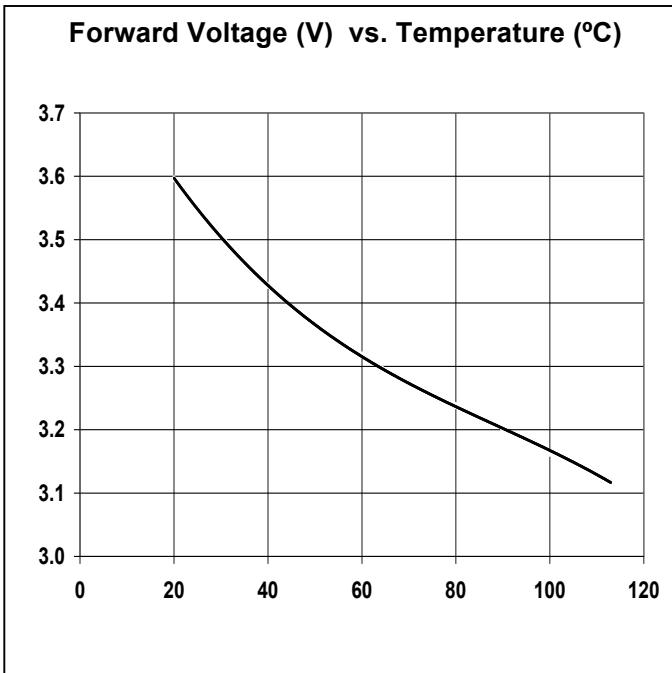
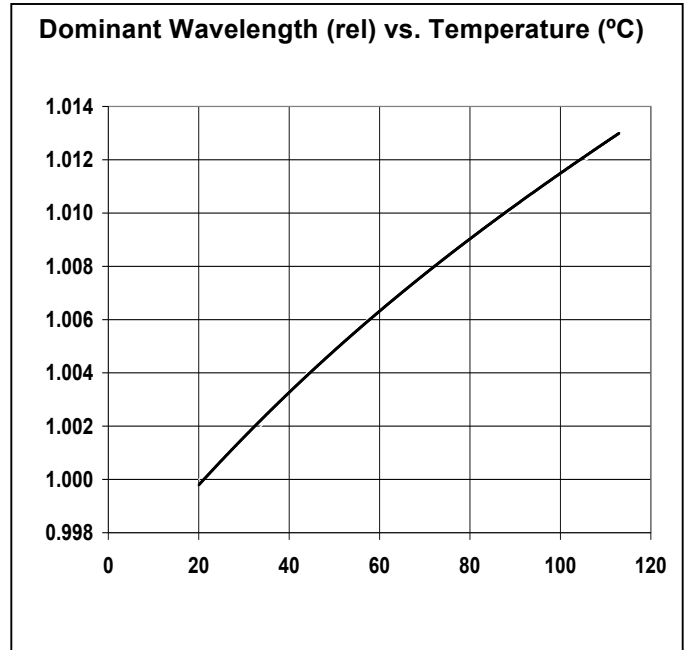
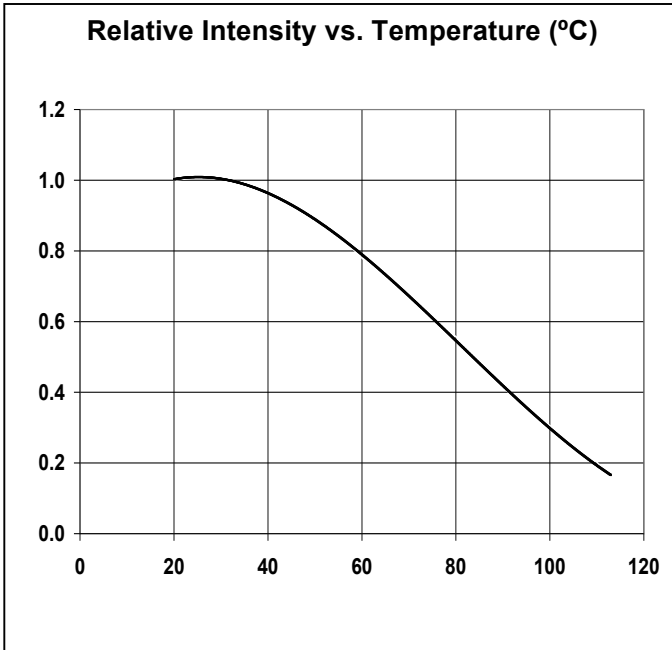

These are typical measurements, representative of specific production lots; actual curves may vary.