

Photo DMOS-FET Relay

Description

The **LT928** is a 1-Form A solid state relay in a 6 pin SMD package that employs optically coupled MOSFET technology to provide 3750V/5000V of input to output isolation. The optically coupled input is controlled by a highly efficient GaAlAs infrared LED and MOS FETs on the output side.

Features

- SMD package 6 Pin type in miniature design (8.8×6.4×3.4mm / .173×.169×.083inch)
- Low driver power requirements (TTL/CMOS Compatible)
- No moving parts
- High reliability
- Arc-Free with no snubbing circuits
- 3750 / 5000Vrms Input/Output isolation
- Tape & Reel version available

Applications

- Telecommunications (PC, Electronic notepad)
- Measuring and Testing equipment
- Industrial control
- Security equipments
- High speed inspection machine

Outline Dimensions

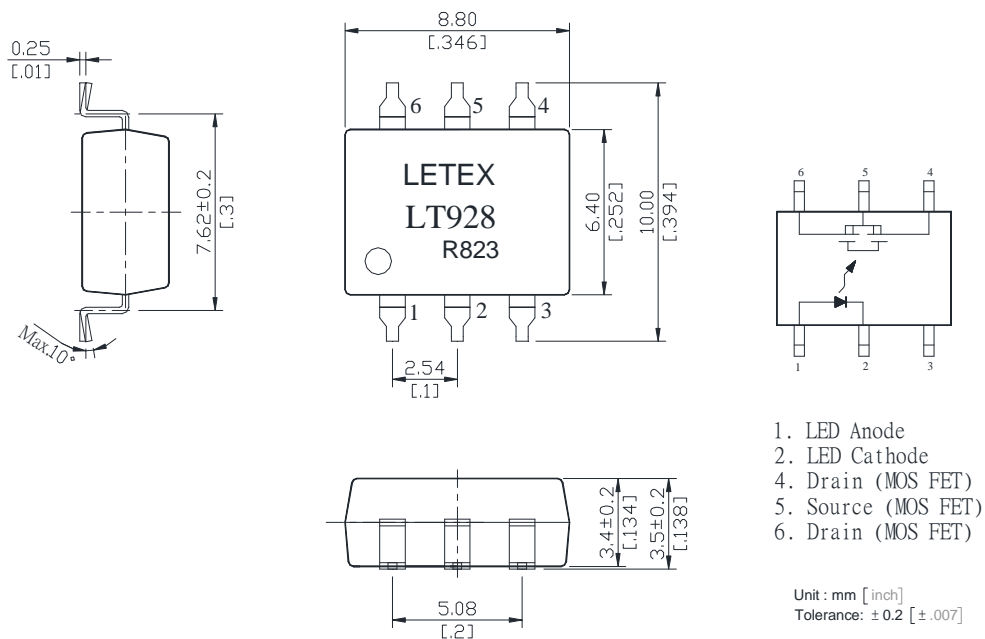

Photo DMOS-FET Relay Specifications

Part Name: LT928

(Load voltage:40V / Load current: AC:4.5A)

Absolute Maximum Ratings (Ambient Temperature: 25°C)

Item		Symbol	Value	Units	Note	
Input	Continuous LED Current	I _F	50	mA		
	Peak LED Current	I _{FP}	1000	mA	f=100Hz, duty=1%	
	LED Reverse Voltage	V _R	5	V		
	Input Power Dissipation	P _{In}	75	mW		
Output	Load Voltage	V _L	40	V(AC peak or DC)		
	Load Current	I _L	4.5	A	A	AC
			5.0	A	B	DC
			7.0	A	C	DC
	Peak Load Current	I _{Peak}	9.5	A	300 μs(1 pulse)	
Output Power Dissipation	P _{out}	500	mW			
Total Power Dissipation		P _T	550	mW		
I/O Breakdown Voltage		V _{I/O}	3750	V _{rms}	RH=60%, 1min	
I/O Breakdown Voltage(Suffix-V)		V _{I/O}	5000	V _{rms}	RH=60%, 1min	
Operating Temperature		T _{opr}	-40 to +85	°C		
Storage Temperature		T _{stg}	-40 to +100	°C		
Pin Soldering Temperature		T _{sol}	260	°C	10 sec max.	

Electrical Specifications (Ambient Temperature: 25°C)

Item		Symbol	MIN.	TYP.	MAX.	Units	Conditions
Input	LED Forward Voltage	V _F		1.3	1.5	V	I _F =10mA
	Operation LED Current	I _{Fon}		1.0	3.0	mA	
	Recovery LED Current	I _{Foff}		0.35	0.8	mA	
	Recovery LED Voltage	V _{Foff}	0.7			V	
Output	On-Resistance	R _{on}		0.033	0.05	Ω	I _F =10mA, I _L =Rating, Time to flow is within 1 sec.
	Off-State Leakage Current	I _{Leak}			1.0	uA	V _L =Rating
	Output Capacitance	C _{out}		690		pF	V _L =0, f=1MHz
Transmis sion	Turn-On Time	T _{on}		1.5	5	ms	I _F =10mA, I _L = Rating
	Turn-Off Time	T _{off}		0.05	2	ms	
Coupled	I/O Isolation Resistance	R _{I/O}	10 ¹⁰			Ω	DC500V
	I/O Capacitance	C _{I/O}		1.0	1.5	pF	f=1MHz



Reference Data

Load current Vs. Ambient temperature

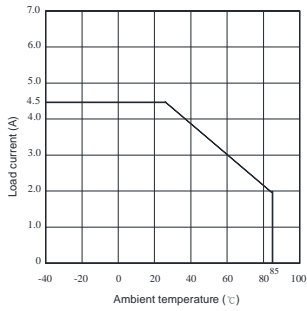

On resistance Vs. Ambient temperature

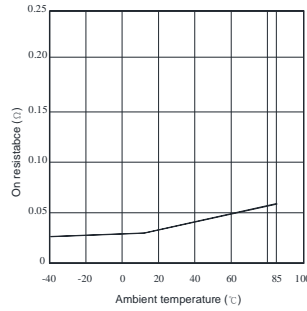

Turn on time Vs. Ambient temperature

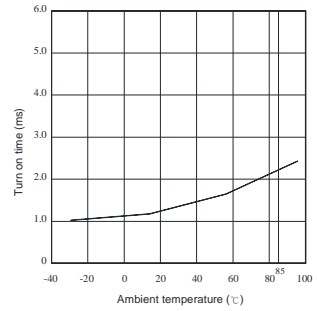

Turn off time Vs. Ambient temperature

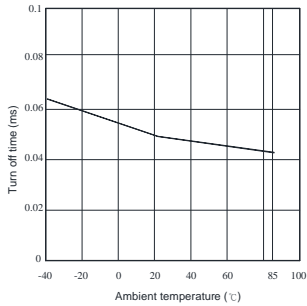

LED operate current Vs. Ambient temperature

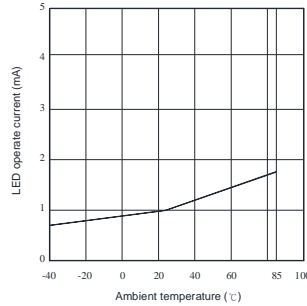

LED turn off current Vs. Ambient temperature

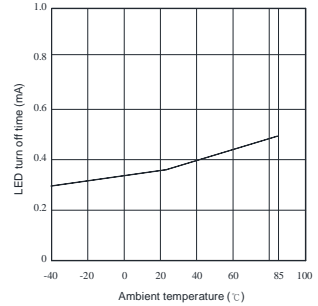

LED forward voltage Vs. Ambient temperature

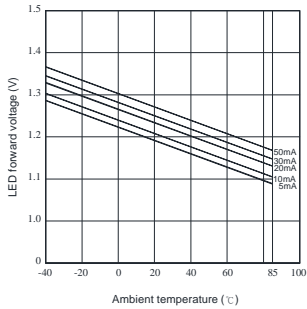

Voltage Vs. current characteristics of output at MOS portion

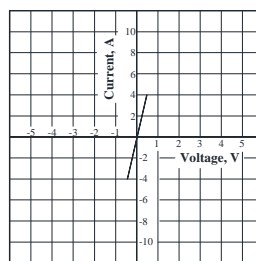

Off state leakage current Vs. Load voltage characteristics

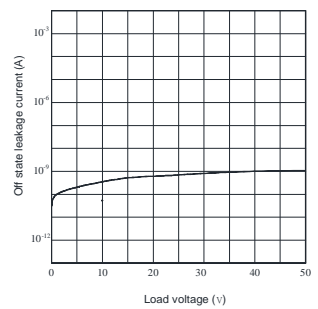

LED forward current Vs. turn on time characteristics

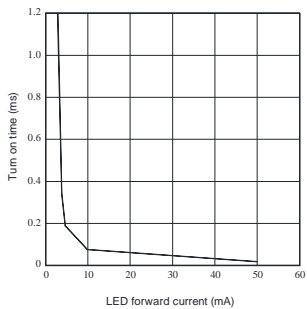

LED forward current Vs. turn off time characteristics

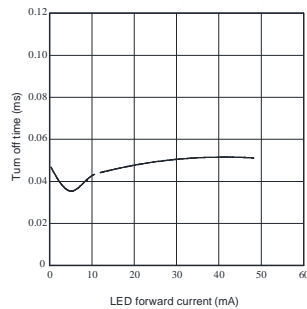

Applied voltage Vs. output capacitance characteristics

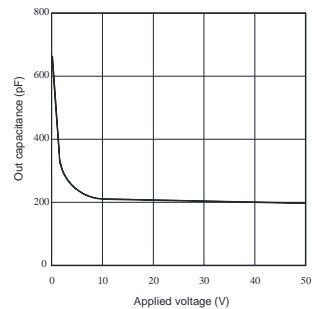

Taping Specifications for Surface Mount Devices

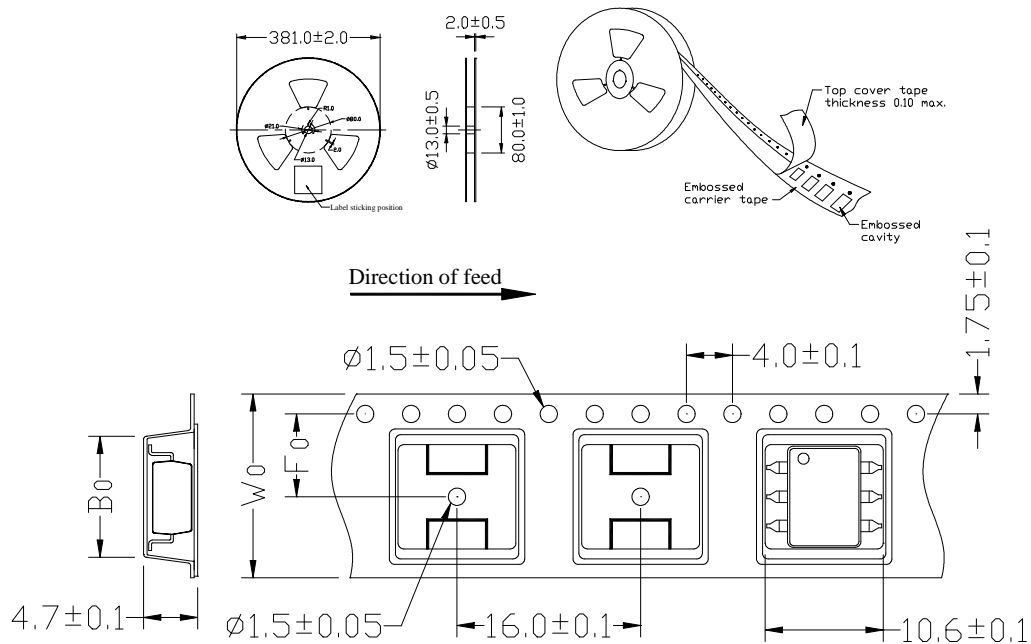

Unit: mm

TYPE	B0±0.1	F0±0.1	W0±0.1	15" REEL/PCS
6P	9.4	7.5	16	1000

Recommended Mounting Pad

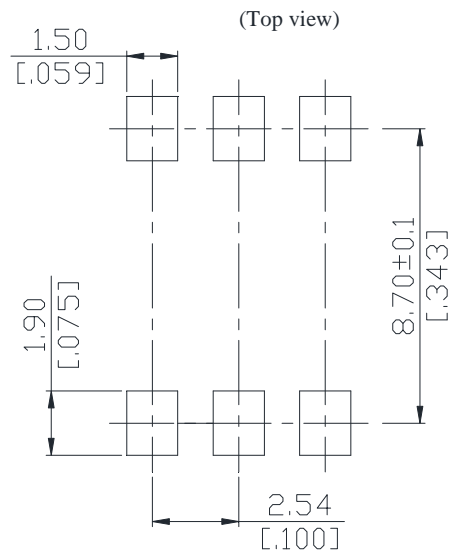

Unit : mm [inch]
Tolerance : ±0.1

Marking

(Each photo MOS Relay shall be marked with the following information)

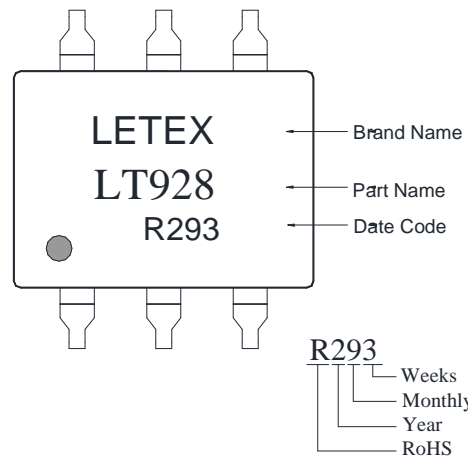

- Note: 1. There shall be leader of 230 mm minimum which may consist of carrier and or cover tape follower by a minimum of 160 mm of carrier tape sealed with cover tape.
2. There shall be a minimum of 160 mm of empty component pockets sealed with cover tape.
3. Devices are pockets in accordance with EIA standard EIA-481-A and specifications given above.