

3535 UVC LED Datasheet



Features:

- Slim Size SMD Package: Design Flexibility
- Purity UVC/UVB Chip: 270-280nm, 310nm
- High Purity Ceramic Base
- Low Thermal Resistance
- Better Heat Dissipation
- Environmental Friendly; ROHS Compliance
- Customized Service Available

Applications:

- Water Purification, Sterilization Humidifier...
- Surface Disinfection, Air Sterilization...
- LED Aquarium Light, LED Plant Growing Light..

TABLE OF CONTENTS

PRODUCT NAMING RULES-----	3
CHARACTERISTICS-----	4
CHARACTERISTIC CURVES-----	5
CHARACTERISTIC CURVES-----	6
CHARACTERISTIC CURVES-----	7
SOLDERING CONDITIONS-----	8
DIMENSION-----	9
PACKAGING-----	10
CAUTIONS ON USE-----	11
CAUTIONS ON USE-----	12
CAUTIONS ON USE-----	13
CAUTIONS ON USE-----	14

PRODUCT NAMING RULES

HQS	XXXX	XX	X	X	XX	G
HQS	Type	Color	Wavelength	Beam Angle	Radiant Flux	Product Series
HuaQiSheng	3535	UVC: 270-280nm	275nm	0: 120°	05: 5-8mW 10: 10-15mW	G

CHARACTERISTICS

SPECIFICATIONS (Ta=25°C)					
Peak Wavelength	Forward Voltage	Forward Current	Viewing Angle	Radiant Flux	Part Number
270-280nm	5.0-8.0V	50mA	120°	5-8mW	HQS-3535UVC005G
270-280nm	5.0-8.0V	100mA	120°	10-15mW	HQS-3535UVC010G

Parameters	Symbol	Value		Unit
Peak Wavelength	λ_p	270-280		nm
Power Dissipation	P_D	IF=50mA	280	mW
Power Dissipation	P_D	IF=100mA	700	mW
Viewing Angle	2θ 1/2	60 / 120		Deg
FWHM	$\Delta\lambda$	11+/-2		nm
Thermal Resistance	$R_{\theta j-b}$	15		°C/W
HBM	HBM	>8		KV
Operating Temperature	T_{OPR}	-30 ~ +60		°C
Storage Temperature	T_{STG}	-40 ~ +100		°C
Reflow Sodering Temperature	T_{SLD}	170-180		°C

TYPICAL CHARACTERISTIC CURVES

Relative Characteristics Curves ($T_c=25^\circ\text{C}$)

Forward Current vs. Forward Voltage ($I_F=50\text{mA}$)

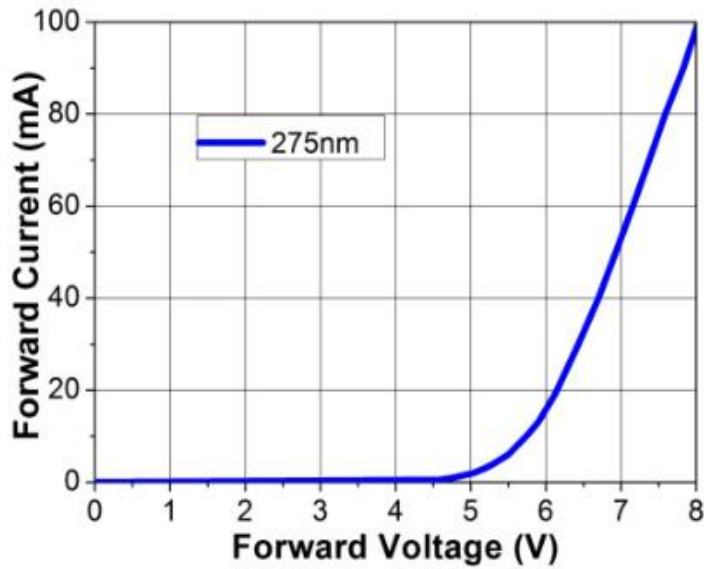

Forward Current vs. Forward Voltage ($I_F=100\text{mA}$)

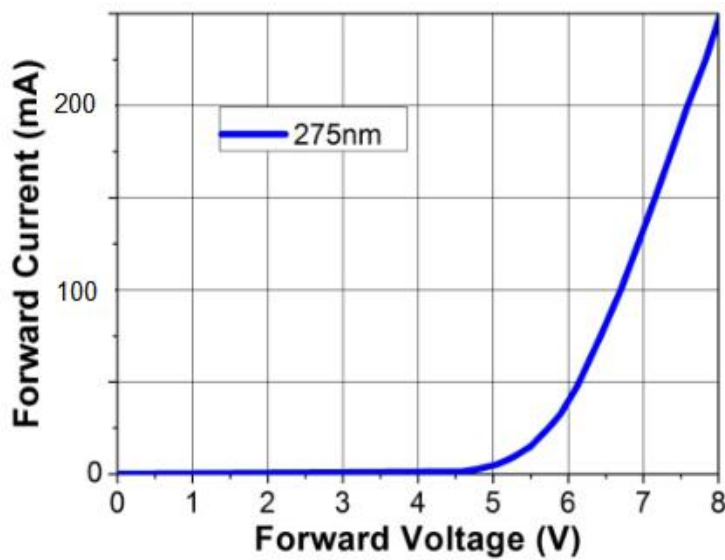

TYPICAL CHARACTERISTIC CURVES

Relative Radiant Flux vs. Wavelength

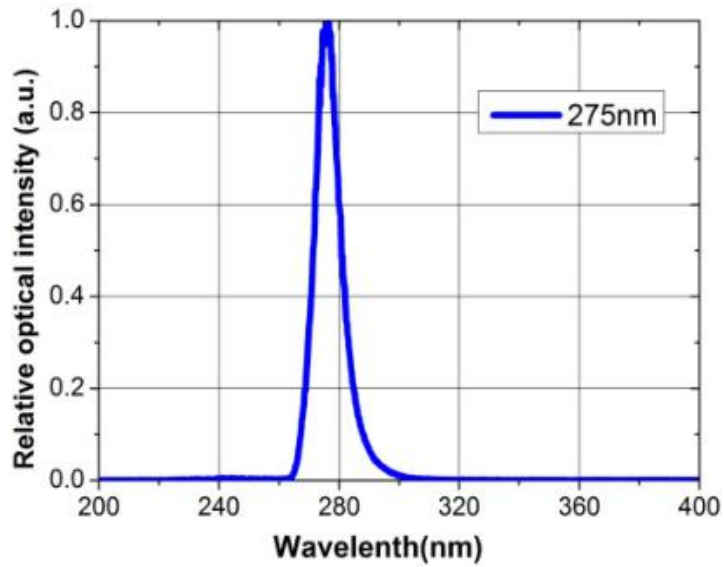

Relative Radiant Flux vs. Forward Current

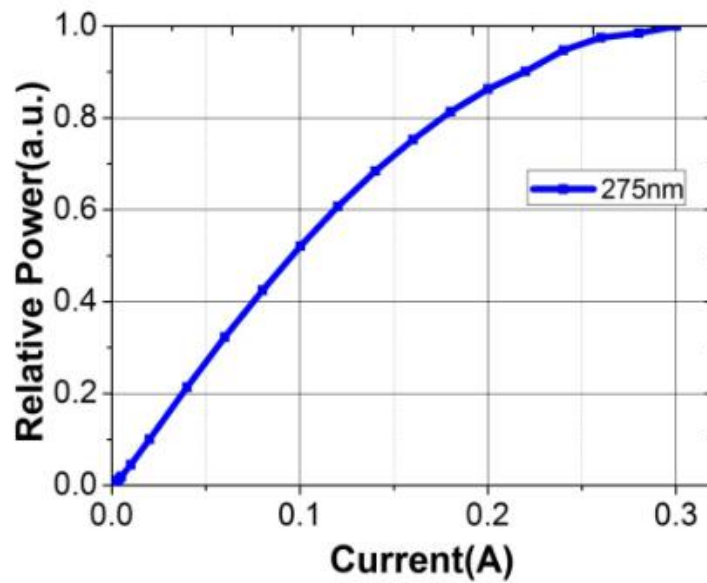

TYPICAL CHARACTERISTIC CURVES

Typical Emission Distribution Curve

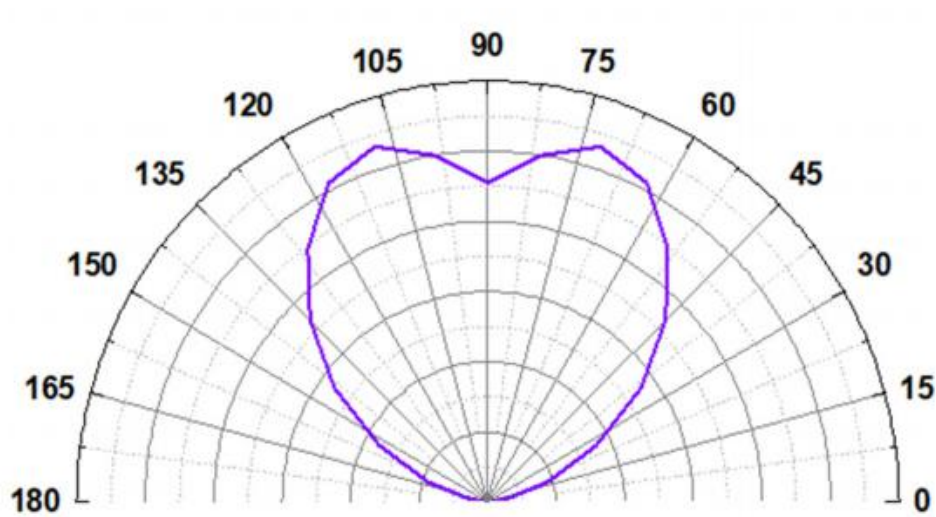

Viewing Angle: 120°

REFLOW SOLDERING PROFILE

REFLOW SOLDERING PROFILE

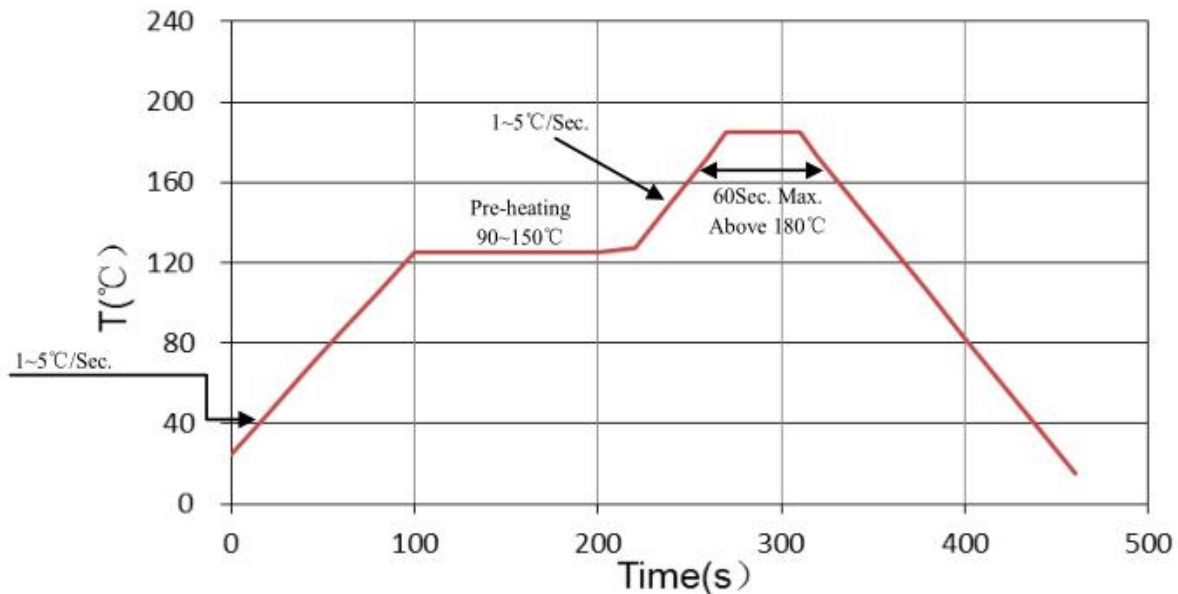

- 1) Temperature Profile should be the scene of the solder paste used type, proportion, reflow soldering equipment to change and adjust accordingly;
- 2) Inappropriate reflux temperature, reflux time may cause the LEDs welding failure. Suggest to do more testing before mass production, to ensure optimum technological parameters;
- 3) Reflow soldering should not be done more than two times;
- 4) When soldering, do not put stress on the LEDs during heating;
- 5) After soldering, do not warp the circuit board.

Repair should not be done after the LEDs have been soldered. When repairing is unavoidable, a double-head soldering iron should be used. It should be confirmed beforehand whether the characteristics of the LEDs will or will not be damaged by repairing.

DIMENSIONS

Unit: mm, Tolerance: +/-0.1mm

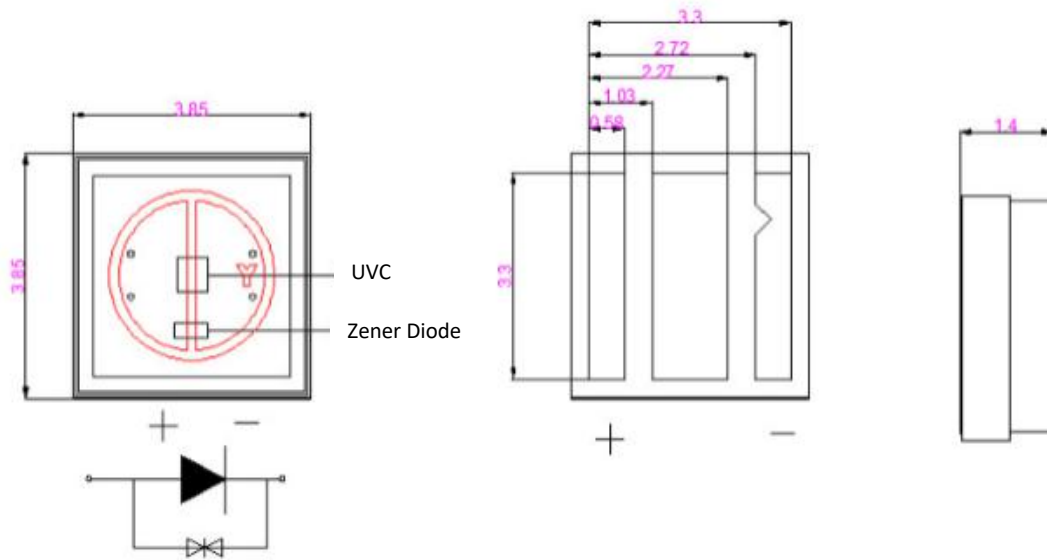

Soldering Pad Dimension

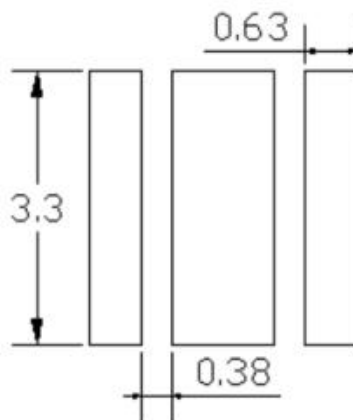

Notes :

*All dimensions are in millimeters.(tolerance:±0.1mm)

PACKAGING

Tape Specifications (Units : mm)

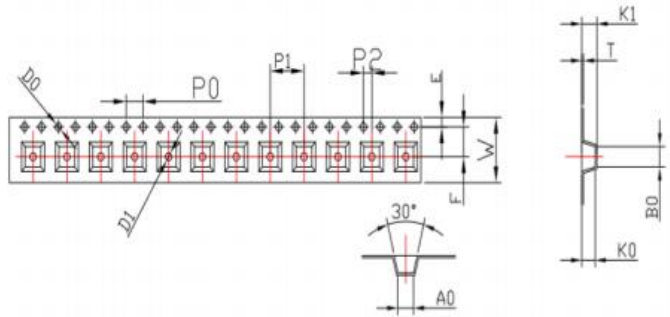

symbol	AO	BO	K0	P0	P1	P2	
Spec	3.65±0.1	3.65±0.1	2.30±0.1	4.0±0.1	8.00±0.1	2.0±0.10	
symbol	T	E	F	DO	W	D1	K1
Spec	6.40±0.05	1.75±0.1	5.50±0.10	1.90 $^{+0.1}_{-0.1}$	12.0±0.3	1.90 $^{+0.1}_{-0.1}$	3.40±0.1

packing details for 60° beam angle

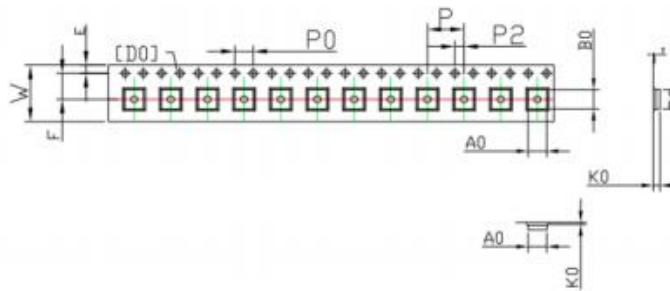

symbol	AO	BO	K0	PO	P	P2
Spec	3.90±0.1	3.90±0.1	1.60±0.1	4.0±0.10	8.0±0.1	2.00±0.10
symbol	W	T	E	F	D	D1
Spec	12.0±0.3	0.30±0.05	1.75±0.10	5.5±0.1	1.50 $^{+0.1}_{-0.1}$	1.50±0.10

packing details for 120° beam angle

Reel Dimensions

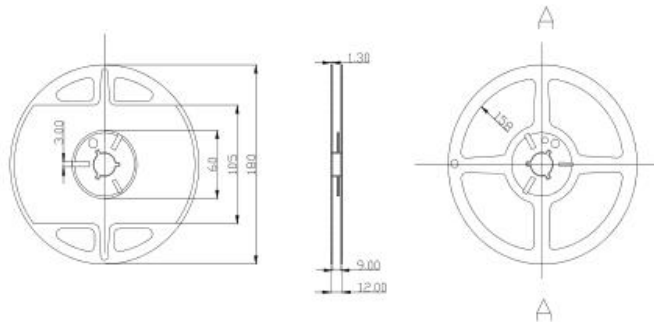

Moisture Resistant Packaging

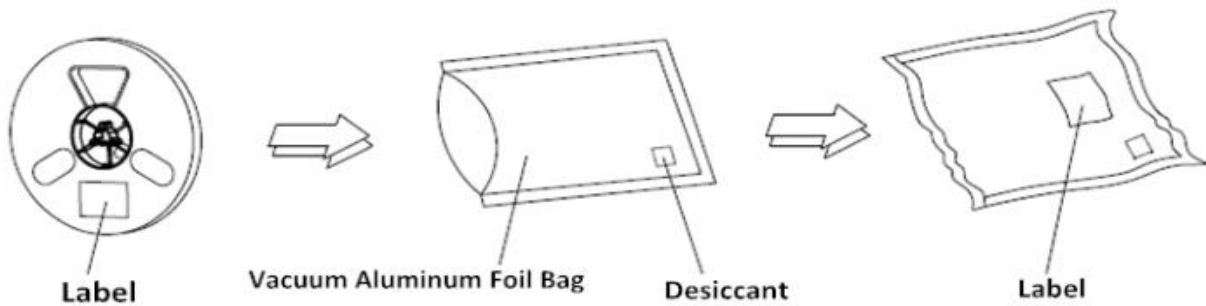

Cautions on Use

1) Moisture-Proof Package

The moisture in the SMD package may vaporize and expand during soldering. The moisture can damage the optical characteristics of the LEDs due to the encapsulation.

2) During Storage

Conditions		Temperature	Humidity	Time
Storage	Before Opening Aluminum Bag	5°C~30°C	<50% RH	Within 1 Year from the Delivery Date
	After Opening Aluminum Bag	5°C~30°C	<60% RH	<= 672 hours
Baking		65+/-5°C	<10% RH	10~24 hours

3) During Usage

- 3.1 The LED should avoid direct contact with hazardous materials such as sulfur , chlorine, phthalate, HF, etc.
- 3.2 The metal parts on the LED can rust when exposed to corrosive gases. Therefore, exposure to corrosive gases must be avoided during operation and storage;
- 3.3 Extreme environments such as sudden ambient temperature changes or high humidity that can cause condensation must be avoided.

4) Cleaning

- 4.1 Do not use brushes for cleaning or organic solvents for washing as avoid residue of organic solvent;
- 4.2 IPA is the recommended solvent for cleaning the LEDs under the following conditions;
- 4.3 Ultrasonic cleaning is not recommended;
- 4.4 Pretests should be conducted with the actual cleaning process to validate that the process will not damage the LEDs.

5) Thermal Management

- 5.1 The thermal design of the end product must be seriously considered, particularly at the beginning of the system design process;
- 5.2 The generation of heat is greatly impacted by the input power, the thermal resistance of the circuit boards and the density of the LED array combined with other components.

Cautions on Use

6) Static Electricity

- 6.1 Wristbands and anti-electrostatic gloves are strongly recommended and all devices, equipment and machinery must be properly grounded when handling the LEDs, which are sensitive against static electricity and surge;
- 6.2 Precautions are to be taken against surge voltage to the equipment that mounts the LEDs;
- 6.3 Unusual characteristics such as significant increase of current leakage, decrease of turn-on voltage, or non-operation at a low current can occur when the LED is damaged.

7) Electrostatic Discharge (ESD)

7.1 The LEDs are sensitive to static electricity or surge voltage and current. The electrostatic Discharge can damage a LED Chip. Also, it can affect a reliability belong to the life time of LED package. When handling LEDs, the following measures against ESD are actively recommended:

- A) Please wear a wrist strap, anti-static clothes, foot wear and gloves;
- B) Please set up a grounded or anti-static paint floors, a grounded or the ability to surge protection-workstation equipment and tools;
- C) ESD protection-worktable/bench, mat made of a conductive materials.



- 7.2 An appropriate grounding is required for all devices, equipment, and machinery used in product assembly. Please apply surge protection after review when designing of commercial products (Curing Module, etc.);
- 7.3 If tools or equipment contain insulating materials such as glass or plastics, the following measures against ESD are strongly recommended;
 - A) Dissipating static charge with conductive materials;
 - B) Preventing charge generation with moisture;
 - C) Plug in the ionizing blowers (ionizer) for neutralizing the charge.
- 7.4 The customer is advised to check if the LEDs are damaged by ESD when performing the characteristics inspection of the LEDs in the application.
- 7.5 ESD damaged LEDs may have a current flow at a low voltage.

Cautions on Use

8) Recommended Circuit

8.1 The current through each LED must not exceed the absolute maximum rating when designing the circuits;

8.2 The LEDs before use must first be welding on the aluminum heat sink or copper heat sink, to avoid overheating LEDs damage.

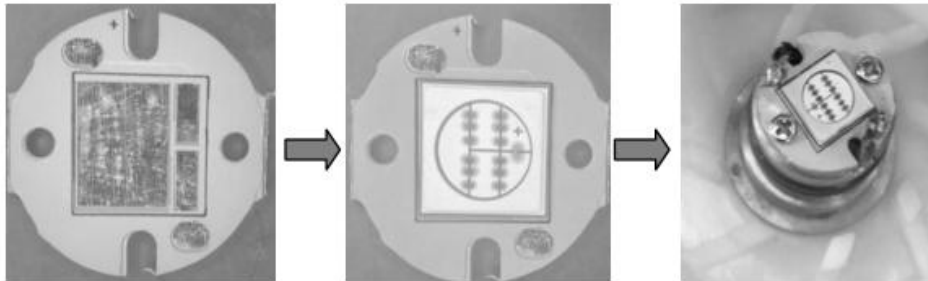

8.3 In general, there can be various forward voltages for LEDs. Different forward voltages in parallel via a single resistor can result in different forward currents to each LED, which also can output different luminous flux values. In the worst case, the currents can exceed the absolute maximum ratings which can stress the LEDs.

Matrix circuit with a single resistor for each LED is recommended to avoid the luminous flux fluctuations.

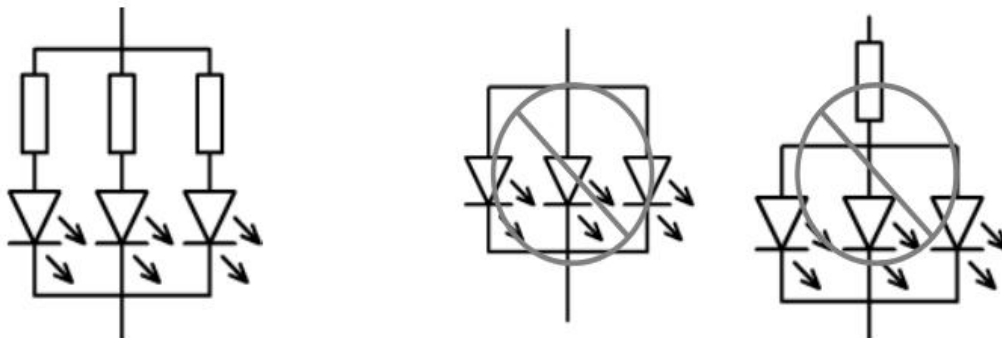

8.4 The driving circuits must be designed to operate the LEDs by forward bias only.

8.5 Reverse voltages can damage the zener diode, which can cause the LED to fail.

8.6 A constant current LED driver is recommended to power the LEDs.

9) Eye Safety Guidelines

9.1 Do not directly look at the light when the LEDs are on;

9.2 Proceed with caution to avoid the risk of damage to the eyes when examining the LEDs with optical instruments.



Cautions on Use

10) Manual handling

10.1 Use Teflon-type tweezers to grab the base of the LED and do not apply mechanical pressure on the surface of the encapsulant.

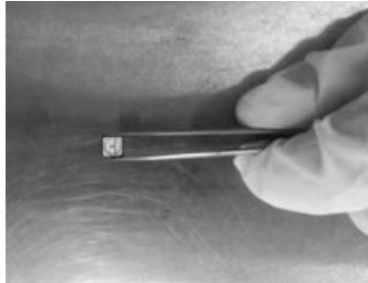

11) Disclaimers

11.1 HuaQiSheng is not responsible for any damages or accidents caused if the operating or storage conditions exceed the absolute maximum ratings recommended in this document;

11.2 The LEDs described in this document are intended to be operated by ordinary electronic equipment;

11.3 It is recommended to consult with Jason when the environment or the LED operation is non-standard in order to avoid any possible malfunctions or damage to product or risk of life or health;

11.4 Disassembly of the LED products for the purpose of reverse engineering is prohibited without prior written consent from HuaQiSheng. All defected LEDs must be reported to Jason and are not to be disassembled or analyzed.

11.5 The product information can be modified and upgraded without prior notice;

11.6 Any other matters not mentioned in this specification, please contact our consulting our sales department.